

FULGOR
MILANO

SINCE
YOUR LIFE | OUR PASSION
1949

FULGOR

MILANO

The kitchen is the place where people share the best moments. It is a place where people meet to converse and share in time honored traditions; but it also holds the opportunity to experiment. The kitchen is the realm of the senses, where flavors combine with smells, colors and different textures of dishes.

It is a place filled with emotion.

This is why Fulgor Milano focuses on the kitchen as a living space.

Technology alone is not enough to make this space a true place to come together and share experiences. You also need passion and love for what goes on everyday around the stove.

The new collection from Fulgor Milano stems from this idea. Characterized by both minor and major innovations which are focused on the functionality of details to make everything you do in the kitchen simpler, more immediate and spontaneous.

SINCE
YOUR LIFE | OUR PASSION
1949

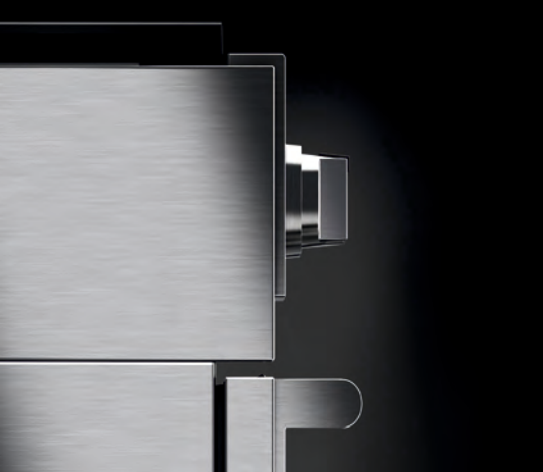

INDEX

PROFESSIONAL

- page 10 - 12 RANGE COOKERS 36" - 48"
- page 13 MULTIFUNCTION 30" OVEN
- page 14 RANGE TOP GAS 36"
- page 15 RANGE HOOD 36" - 48"
- page 16 - 21 OUTDOOR BARBECUE 41"

BUILT-IN OVENS

- page 33 MULTIFUNCTION 30"
- page 35 MULTIFUNCTION PYRO 600
- page 36 MULTIFUNCTION 600
- page 37 MULTIFUNCTION 600 SIDE OPENING

BUILT-IN COMPACT 450

- page 42 STEAM OVEN
- page 45 MICROWAVE OVEN
- page 47 MULTIFUNCTION OVEN
- page 49 WARMING DRAWER
- page 51 WINE COOLER
- page 51 BASIC DRAWER

REFRIGERATION

- page 52 - 53 FRIDGE / FREEZER

INDUCTION HOBS

- page 57 1000 INDUCTION 4 ZONES
- page 58 900 INDUCTION 5 ZONES
- page 59 800 INDUCTION 5 ZONES
- page 60 800 INDUCTION 4 ZONES
- page 61 600 INDUCTION 4 ZONES
- page 62 900 CURVED INDUCTION 4 ZONES
- page 63 900 INDUCTION WITH GAS WOK

GAS HOBS

- page 68 1000 4 BURNERS
- page 69 900 5 BURNERS
- page 70 800 5 BURNERS
- page 71 600 4 BURNERS



FULGOR
MILANO





PROFESSIONAL



FULGOR
MILANO

PROFESSIONAL



CLASSIC BEAUTY

Sofia is a solid, generously sized freestanding range with a clean and rigorous style.

Designed, developed and engineered in Italy to exceed all expectations of quality, performance and style. Sofia will captivate the most discerning chef with nuanced features that are both traditional yet innovative.

PROFESSIONAL HIGH PERFORMANCE RANGE



TOTAL VERSATILITY

Six cooking areas, all equipped with double burners and heavy-weight cast iron pan supports. Cook what you want, where you want, when you want.

TOTAL ACCESS AT YOUR FINGER TIPS

Multiple baking functions, timed bake, meat probe, and a variety of other customizable settings and baking features.

COOL DOOR

4 thermo-reflecting glass panes door ensures an external temperature of <math>< 50^{\circ}\text{C}</math> even during the pyrolytic cleaning cycle (

REMOVABLE GRILL

The telescopic grill, made from durable material, means you can take your dishes out easily and check to see if the food is cooked.



SOFT CLOSING DOOR

Perfect visibility and clean lines are essential components of Sofia's character. The wide glass, cool touch door is equipped with a shock absorber for stable, assisted closure (soft closing) of the oven.

SOFIA IS AN INDIVIDUAL

We designed a professional range with a style and presence unique to her name.

Sofia integrates the use of stainless and brushed aluminum for a design that is elegant and distinctive.



PROFESSIONAL

TECHNOLOGY HAS A SOUL



PROFESSIONALLY CRAFTED









This multifunction oven, combines all the features of a fully-equipped professional range cooker with a stainless steel design which highlights the elegance and uniqueness of Italian style.

PROFESSIONAL
MULTIFUNCTION RANGE COOKER

FULGOR
MILANO

FM-CEG-1216-FSSS



-  Fingerprint proof stainless steel
-  Cool Door < 50°C
-  Dual Internal Ventilation
-  Dual Burner
-  Soft Closing
-  Multi-level cooking
-  Automatic self-cleaning with PYROLYSIS
-  Digit Control
-  Internal capacity 161 litres
-  Energy Class Efficiency A

48" PROFESSIONAL RANGE

Finish: professional stainless steel
Digital Control
Energy Class A

HOB

Powered by natural gas with the option of converting to LPG.
8 burners with dual control adjustment from 350 to 4500W
Automatic re-ignition
Hob surface in matt black porcelain enamel
Professional cast iron pan supports
Steel rotary controls

MULTIFUNCTION ELECTRONIC OVEN

6 Digit touch control: digital timer + rotary controls
Dual True convection
PYROLYSIS Self-cleaning
Booster to rapidly reach the pre-selected temperature
Cool touch (< 50°C) with soft closing door
Black porcelain enamel interior

STANDARD OVEN ACCESSORIES:

Probe for checking food temperatures
1 Fully retractable telescopic rack
2 flat metal grills
1 enamel tray with anti-splash insert
Internal lighting
Internal capacity 161 litres

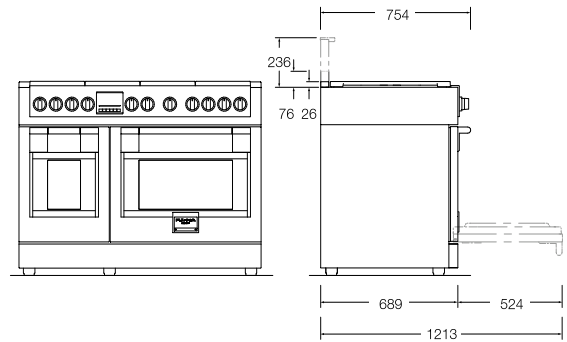

Touch proof stainless steel
Code EAN 8019801017256

HOB FEATURES	
Type	Gas
Double crown burners	6
Burner power (min-MAX)	350-4500W

FM-CEG-910-FSSS



Fingerprint proof
stainless steel



Cool Door
< 50°C



Dual
Internal
Ventilation



Dual
Burner



Soft
Closing



Multi-level
cooking



Automatic
self-cleaning
with PYROLYSIS



Digit
Control



Internal
capacity
161 litres



Energy
Class
Efficiency

36" PROFESSIONAL RANGE

Finish: professional stainless steel
Digital Control
Energy Class A

HOB

Powered by natural gas with the option of converting to LPG.
6 burners with dual control adjustment from 350 to 4500W
Automatic re-ignition
Hob surface in matt black porcelain enamel
Professional cast iron pan supports
Steel rotary controls

MULTIFUNCTION ELECTRONIC OVEN

6 Digit touch control: digital timer + rotary controls
Dual True convection
PYROLYSIS Self-cleaning
Booster to rapidly reach the pre-selected temperature
Cool touch (< 50°C) with soft closing door
Black porcelain enamel interior

STANDARD OVEN ACCESSORIES:

Probe for checking food temperatures
1 Fully retractable telescopic rack
2 flat metal grills
1 enamel tray with anti-splash insert
Internal lighting
Internal capacity 161 litres

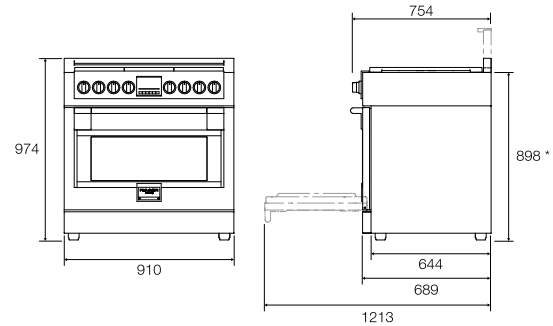

Touch proof stainless steel
Code EAN 8019801017256









HOB FEATURES	
Type	Gas
Double crown burners	6
Burner power (min-MAX)	350-4500W

PROFESSIONAL
GAS RANGE

FULGOR
MILANO

FM-CGG-910-FSSS



-  Fingerprint proof stainless steel
-  Cool Door < 50°C
-  Dual Internal Ventilation
-  Dual Burner
-  Soft Closing
-  Gas powered
-  Internal Capacity 161 litres
-  Digit Control
-  Energy Class Efficiency A

36" PROFESSIONAL RANGE

Finish: Professional stainless steel
Digital Control
Energy Class A

HOB

Powered by natural gas (option of converting to LPG)
6 burners with dual control adjustment from 350 to 4500W (GN)
Automatic re-ignition
Hob surface in matt black porcelain enamel
Professional cast iron pan supports
Steel rotary controls

OVEN

Powered by natural gas with the option of converting to LPG
6 Digit touch control: digital timer + rotary controls
Double convection fan
Cool touch (< 50°C) with soft closing door
Black porcelain enamel interior
Cool touch (< 50°C) with soft closing door
1 Fully retractable telescopic rack
2 chromed racks
1 enamel tray with anti-splash insert
Internal lighting
Internal capacity 161 litres

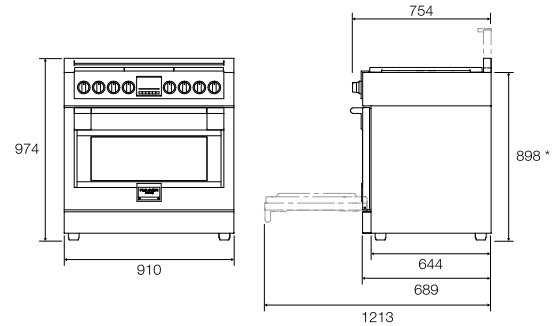

See technical data on page 244



Touch proof stainless steel
FSRC 3606 GG ED 2F X
Code EAN 8019801017263

HOB FEATURES	
Type	Gas
Double crown burners	6
Burner power (min-MAX)	350-4500W

30"
PROFESSIONAL MULTIFUNCTION OVEN

FM-FMP-758-BISS



FULGOR
MILANO



Fingerprint proof
stainless steel



Internal
capacity
123 litres



Dual
Internal
Ventilation



Cool Door
< 50°C



Soft
Closing



Multi-level
cooking



Automatic
self-cleaning
with PYROLYSIS



Digit
Control

30" PROFESSIONAL OVEN
MULTI-FUNCTION ELECTRONIC SELF-CLEANING
Finish: Professional stainless steel

PERFORMANCE

11 cooking functions
BOOST to rapidly reach the pre-selected temperature
Self-cleaning with PYROLYSIS (2 cycles)

FEATURES

6 Digit touch control: digital timer + stainless steel rotary controls
Interior in black porcelain enamel
Internal lighting
Internal capacity 123 litres

SAFETY

Dual True convection
PYROLYSIS Self-cleaning
Cool touch (< 50°C) with soft closing door
2 speed tangential cooling ventilation
Keypad and door safety lock function
Smoke catalyst

STANDARD ACCESSORIES

Probe for checking meat temperature
1 Fully retractable telescopic rack
2 chromed racks
1 enamel tray with anti-splash insert

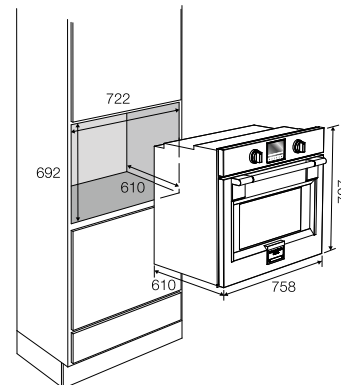

Touch proof stainless steel
Code EAN 8019801017287



PROFESSIONAL RANGE TOP 36"

FM-PGR-910-6BSS



Fingerprint proof stainless steel



Gas powered



Dual Burner

36" RANGE TOP

6 gas burners with dual regulation
Finish: Professional stainless steel and matt black pan supports

PERFORMANCE

Adjustable burner power from 375 to 4500W for simmering and high heat

SAFETY

Electronic ignition with re-ignition
Gas detection and stop gas system

STANDARD ACCESSORIES

Professional cast iron pan supports
Professional front controls in stainless steel

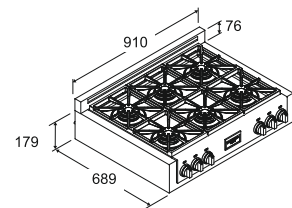

Touch proof stainless steel
Code EAN 8019801017294

HOB FEATURES







Type	Gas
Double crown burners	6
Burner power (min-MAX)	350-4500W



PROFESSIONAL RANGE HOOD

FM-CPR-912-WMSS (36") FM-CPR-1216-WMSS (48")
Coming Soon



-  Fingerprint proof stainless steel
-  Extraction Capacity (max) 1000 m³/h
-  Noise level Db
-  Wall-hung installation
-  LED lighting
-  External dimension 36" inches

36" WALL-MOUNTED HOOD
 Finish: Professional stainless steel
 Energy Class A

FEATURES
 Stainless steel baffle filters
 Oil collector

PERFORMANCE
 Internal motor 950 m³/h
 4 speed settings
 LED lighting
 Suitable for ducted installation

OPTIONAL ACCESSORIES
 Stainless steel chimney

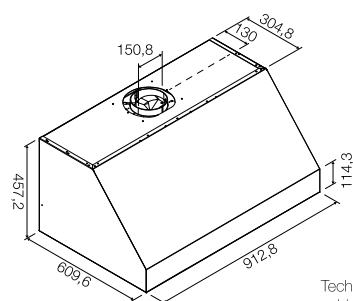

Technical drawing subject to change



Touch proof stainless steel
 Code EAN 8019801018024



Steel chimney
 Code EAN 8019801018086

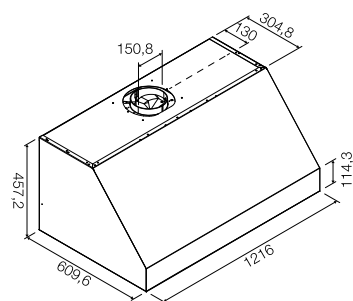



FULGOR
MILANO





PROFESSIONAL OUTDOOR BARBECUE



PROFESSIONAL BARBECUE

DETAILS THAT MAKE THE DIFFERENCE



QUICK AND EASY CLEANING AND MAINTENANCE

Thanks to its structure and the stainless steel cooking surfaces, cleaning of the barbecue is easy and practical. Stainless steel is a hygienic material which is bacteria-resistant and does not alter the taste of the food with which it comes into contact.



All the elements of the barbecue slot together and can be easily disassembled without using any tools.



The grill racks and plates can be easily removed and washed.



Even the smallest internal components can be removed to thoroughly clean the barbecue



LIDS

Possibility of choosing between a simple cover which protects the cooking surface after cooking and a high cover for cooking roasts whilst maintaining the temperature inside. Fitted with a thermometer and a wide-grip handle.



BATTERY FOR IGNITING THE GAS BURNERS

The barbecue comes with a long-lasting battery that lets you ignite the burners electronically, even when you position it far from electrical power supplies.

STEEL CONTROLS

Professional size side controls provide a better grip for adjusting the temperature.

FM-BPR-1046-BISS

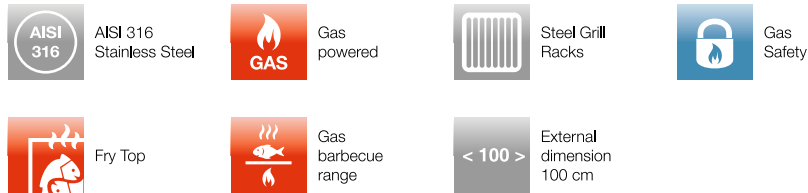
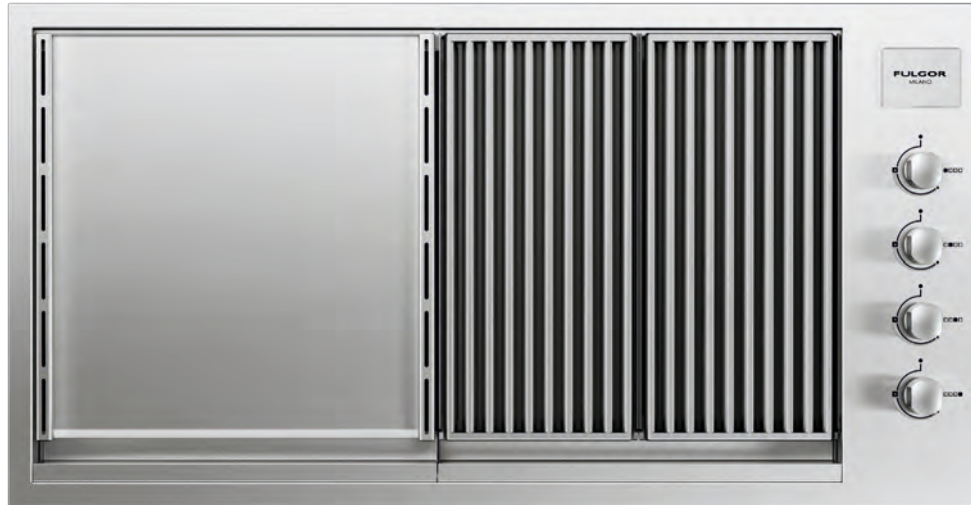

GAS BARBECUE
FOR OUTDOOR USE ONLY
Finish: 316 stainless steel

PERFORMANCE
4 gas burners for use with GN and LPG,
Total gas power output: 14 kW
Grilling and roasting

FEATURES
Side-mounted stainless steel controls
Back-up battery for electronic ignition
2 stainless steel grill racks (divided in two)
1 stainless steel plate (fry top)
Removable drip trays, 2 in the front and 3 under the burners
(for fat, oil and cooking residue)

SAFETY
GasProtekt
Gas detection and stop gas system

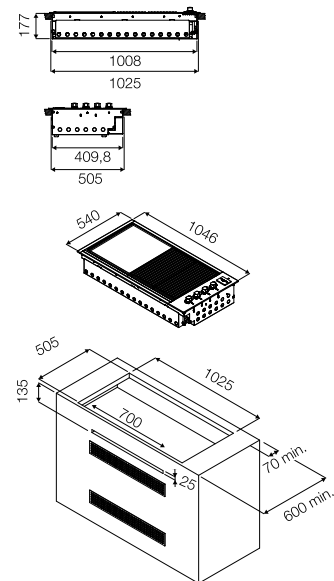

Stainless steel
Code EAN 8019801014583

FM-BHL-1046-BISS

HIGH LID



AISI 316
Stainless Steel



High Stainless
Steel Cover

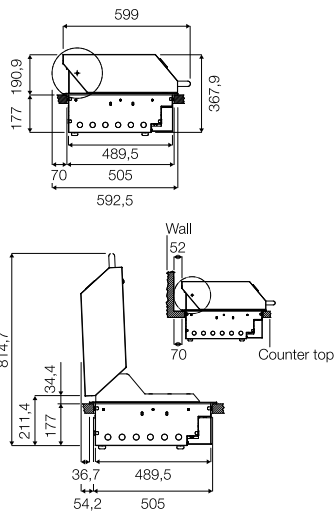

FM-BSL-1046-BISS

SLIM LID



AISI 316
Stainless Steel



Low Stainless
Steel Cover

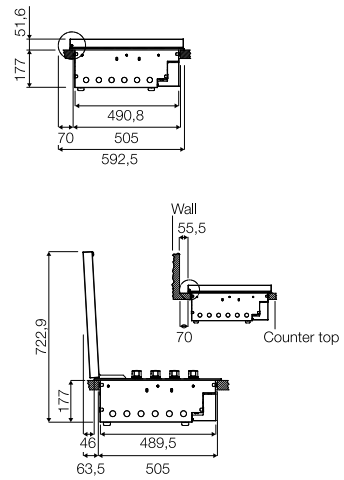

Stainless steel
Code EAN 8019801014606



Stainless steel
Code EAN 8019801014590



FULGOR
MILANO





BUILT-IN OVENS



CREACTIVE *DISPLAY*



PIZZA FUNCTION 350°C

Two large pizzas can be cooked simultaneously in only two and a half minutes thanks to temperatures that reach a maximum of 350°C.

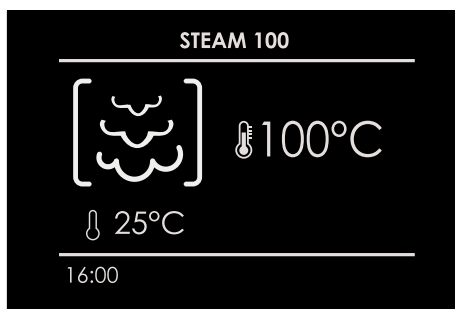

STEAM COOKING

For healthy and genuine food. You can choose between just using the steam function, or combining it with the conventional oven and grill modes.

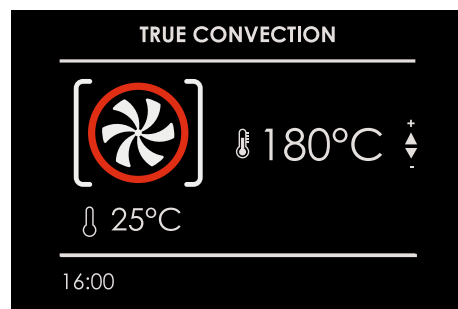





MULTI-LEVEL COOKING

Internal heat remains constant throughout the oven, while smells and flavours are kept separate thanks to the fan-assisted ventilation system.





MICROWAVE AND RING

 150°C
 300W
 25 °C
 TIME 00':12"



16:00



MW COOKING + HOT AIR

This system combines microwave and convection modes so dishes can be cooked quickly or at low temperatures.

MICROWAVE AND GRILL

 300W
 TIME 00':12"



16:00



MW COOKING + GRILL

When you want to brown or roast meat in a short amount of time, you combine the microwave and the grill modes.

TRUE CONVECTION

 180°C
 25°C

16:00



FAN-ASSISTED COOKING

Perfect for baking. The convection fan cooks the food uniformly, for fragrant pastries.





CREACTIVE

A TOUCH OF MAGIC IN THE KITCHEN



TOUCH CONTROL PANEL

Everything is under control with just one touch on the Creative display.

INTUITIVE

It only takes a moment to find the desired function, quickly and easily.



MULTI-FUNCTION

All functions you need to get the best results every day while preparing your recipes.

CUSTOMIZABLE RECIPES

Recipes to suite every palate have been pre-programmed, but you can modify and customise them to your specific requirements.

MULTIFUNCTION OVENS

ACCESSIBLE TECHNOLOGY



CREACTIVE

With the CREACTIVE, direct touch control, operating system, FULGOR MILANO introduces a modern, intuitive way of cooking which allows you to prepare elaborate recipes with just a few commands and receive updates during the cooking cycle.



PIZZA MODE 350 °C

For cooking 2 large pizzas simultaneously in just two minutes and 35 seconds.



PYRO-GREY

The special composition of this light grey, nickel-free enamel reduces the toxicity of materials which come into contact with food and makes it easier to dispose of and recycle the components.



SMOKE CATALYST (SELF-CLEANING OVENS)

Eliminates fumes that form during the self-cleaning cycle and prevents them from spreading to the kitchen.



SAFETY DOOR WITH LOCKING DEVICE

The door, fitted with 4 panes of heat-resistant glass, lowers the temperature (< 50°C) of the outer glass pane even during the self-cleaning cycle (460°C) and has a locking device which can be activated independently. Just press the + and - symbols for 3 seconds to block access to the oven (repeat the procedure to unblock it).

SEE-THROUGH GLASS INNER DOOR

It provides a panoramic view from the outside of the oven door.

THE STRENGTH OF A GREAT OVEN LIES IN THE QUALITY OF ITS DETAILS



QUALITY ACCESSORIES

FULGOR MILANO provides accessories to make life easier in the kitchen, such as the heat probe and large roasting spit.

STEEL PANEL

The multifunction ovens series are fitted with a steel panel and fan which lines the rear wall of the oven.

GLASS TRAY

The new glass trays used by FULGOR MILANO are made of highly heat-resistant material which you can cook on directly without having to use other pans. Dishwasher safe.



SOFT CLOSING DOOR

The soft-closing door allows you to gently close the oven door with a simple push, braking the impact; even without using your hands, which are free to perform other tasks.



FULLY REMOVABLE TELESCOPIC RAILS

Our fully retractable telescopic rail makes accessibility to your cooking more convenient.



MEAT PROBE

Precise cooking performance with our meat probe, available in all touch control ovens.

INTERNAL LIGHTING













The evenly distributed light sources light the inner oven perfectly.





FM-FMP-750-BISS



-  Fingerprint proof stainless steel
-  Digit Control
-  Multi-level cooking
-  Cool Door < 50°C
-  Automatic cooking
-  Telescopic Rails 2 levels
-  BOOST rapidly reach pre-selected temperature
-  Automatic self-cleaning with PYROLYSIS
-  Temperature measurement probe
-  Internal capacity 123 litres
-  FREE NICKEL
-  Energy Class Efficiency A

XXL SELF-CLEANING ELECTRONIC MULTIFUNCTION OVEN
 CREATIFE operating system
 Finish: Fingerprint resistant stainless steel
 Energy Class A

PERFORMANCE
 15 cooking modes
 Automatic cooking with Pre-selected, customizable recipes (weight, cooking time and temperature)
 BOOST to rapidly reach the pre-selected temperature
 PYROLYSIS Self-cleaning 2 cycles)

FEATURES
 Control panel with touch controls
 Dual convection fan
 Black Porcelain enamel interior
 Internal lighting with 3 light spots
 Internal capacity 123 litres

SAFETY
 Cool door (< 50°C) with 4 panes of glass
 2 speed tangential cooling ventilation
 Keypad and door safety lock function
 Smoke catalyst

STANDARD ACCESSORIES
 Meat probe
 food temperatures
 2 fully removable chrome telescopic racks,
 1 wide enamelled tray with anti-splash insert
 2 flat grill racks
 Power cable

ACCESSORIES ON REQUEST
 FK 30" X frame for vertical installation with Compact 45cm ovens

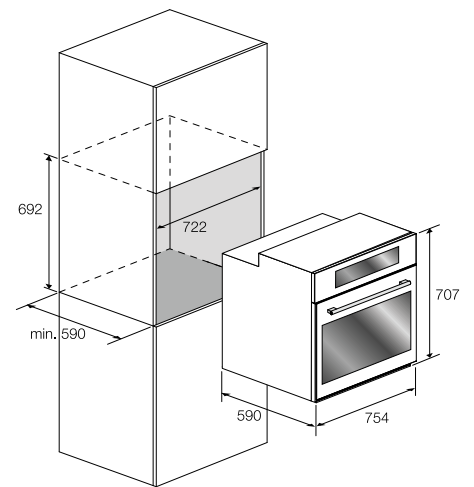

Fingerprint resistant stainless steel
 Code EAN 8019801017300



30" stainless steel frame for Compact 45cm ovens
 FM-AOF-450-BISS
 Code EAN 8019801014729













COOKING BECOMES CHILD'S PLAY



FM-FMP-600-BISS



-  Fingerprint proof stainless steel
-  FREE NICKEL Nickel free enamel
-  Multi-level cooking
-  Temperature measurement probe
-  Automatic cooking
-  Cool Door < 50°C
-  BOOST rapidly reach pre-selected temperature
-  Telescopic Rails 2 levels
-  A+ Energy Class Efficiency
-  Automatic self-cleaning with PYROLYSIS

MULTIFUNCTION ELECTRONIC SELF-CLEANING OVEN

CREACTIVE operating system
Energy Class A+
Finish: Touch proof stainless steel

PERFORMANCE

Automatic cooking with pre-selected and customizable recipes (weight, cooking time and temperature)
15 modes
BOOST to rapidly reach the pre-selected temperature
PYROLYSIS Self-cleaning

FEATURES

Control panel with touch controls
Pyro-grey enamel
Interior (nickel-free)
Internal lighting
Internal capacity 65 litres

SAFETY

Cool door (< 50°C) with 4 panes of glass
Oven door with automatic safety lock during self-cleaning cycle
Control panel with safety lock
2 speed tangential cooling ventilation
Smoke catalyst

STANDARD ACCESSORIES

Meat probe
2 glass trays
2 fully retractable telescopic rails
2 flat chromed racks
Power cable

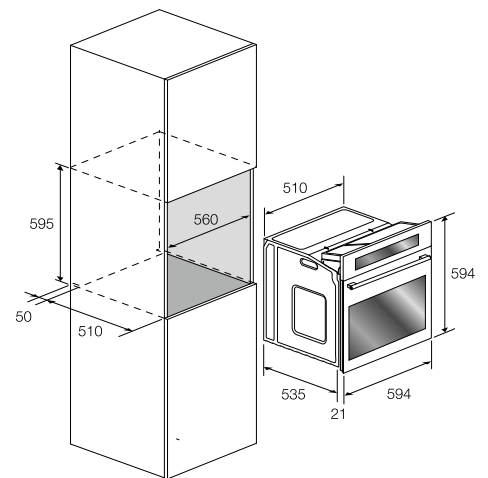

Touch proof stainless steel
Code EAN 8019801017317



Black glass
FM-FMP-600-BIBL
Code EAN 8019801017386

FM-FMF-600-BISS



-  Fingerprint proof stainless steel
-  FREE NICKEL Nickel free enamel
-  Multi-level cooking
-  Temperature measurement probe
-  Automatic cooking
-  Safe Door
-  BOOST rapidly reach pre-selected temperature
-  Telescopic Rails 2 levels
-  Soft Closing
-  CLEAN Programmes Automatic Cleaning
-  A++ Energy Class Efficiency

MULTIFUNCTION ELECTRONIC OVEN

CREACTIVE operating system
Energy Class A++
Soft Closing
Finish: Touch proof stainless steel

PERFORMANCE

15 modes
Automatic cooking with pre-selected and customizable recipes (weight, temperature, cooking time)
BOOST to rapidly reach the pre-selected temperature
CLEAN, assisted cleaning cycle

FEATURES

Control panel with touch controls
Pyro-grey enamel interior (nickel-free)
Steel fan & rear cover
Internal lighting
Internal capacity 65 litres

SAFETY

Safe door (4 cool glass panes)
Soft closing door
Tangential cooling ventilation

STANDARD ACCESSORIES

Heat probe for checking food temperatures
2 tempered glass trays
2 fully retractable telescopic rails
2 chromed racks
Power cord with plug

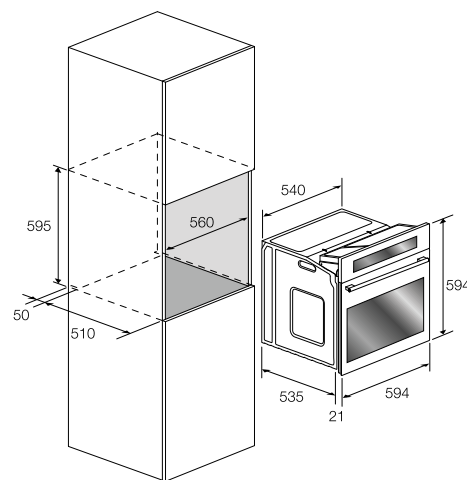

Touch proof stainless steel
Code EAN 8019801017331



Black glass
FM-FMF-600-BIBL
Code EAN 8019801017409



FM-FMD-600-BISS



Fingerprint proof stainless steel



Nickel free enamel



Multi-level cooking



Temperature measurement probe



Automatic cooking



Safe Door



BOOST rapidly reach pre-selected temperature



Telescopic Rails 2 levels



Energy Class Efficiency



CLEAN Programmes Automatic Cleaning

MULTIFUNCTION ELECTRONIC OVEN

Side swing opening door, reversible
CREACTIVE operating system
Energy Class A++
Finish: touch proof stainless steel

PERFORMANCE

15 modes
Automatic cooking with pre-selected and customisable recipes (weight, temperature, cooking time)
BOOST to rapidly reach the pre-selected temperature
CLEAN, assisted cleaning cycle

FEATURES

Control panel with touch controls
Pyro-grey enamel interior (nickel-free)
Steel fan & rear cover
Internal lighting
Internal capacity 65 litres

SAFETY

Safety door (4 cool glass panes)
Tangential cooling ventilation

STANDARD ACCESSORIES

Meat probe
2 Glass trays
2 fully removable telescopic rails
2 chromed racks
Power cord with plug

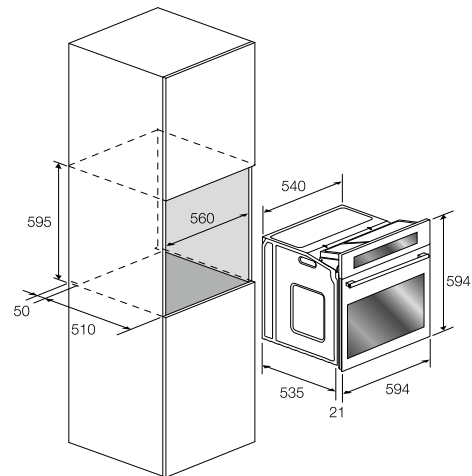

Touch proof stainless steel
Code EAN 8019801017348



FULGOR
MILANO



CREACTIVE



COMPACT 45

COMPACT 45



UNIQUE STYLE

The Compact 45 range combines modularity and technological multi-functionality with a stylish design.

Ideal for people who likes the kitchen to meet with his deep expectations in cooking, and also looking for unique design ,convenience and performance to share with family and friends, thanks to these tools suitable for making it a professional environment.

CREACTIVE

COMPACT 45 STEAM

Steam cooking enhances the natural flavours of food and maintains unaltered the qualities of food, especially vegetables and grains.

The combination with other functions lets you cook with traditional and multi-function modes or to add steam to make more delicate the taste of your recipes.

COMPACT 45



GASTRONORM CONTAINERS SET (Optional*)

The Gastronorm stainless steel containers allow to cook different types of food at the same time without mixing flavors.

Accessories page 238



PERFORATED POT WITH COVER

The perforated pot with cover, supported by a steel rack, is perfect to cook with steam.

CONDENSATION AND STEAM RECOVERY

During the cooking cycle, an exclusive system allows to condense and recover the steam, taking it back to the water tank. It helps to cook for a longer time than the usual, without the need to open the oven door to add water.

WATER TANK

A removable tank of 1.2 lt. is available on the right side of the oven to make it easier to fill it up with water.



DESCALING FILTER

Helps to eliminate lime scale in the water, preventing its deposit on the inner walls and reducing the need of cleaning cycles.

COOKING CHAMBER INTERIOR











The inner walls of the oven are made of 10/10 high quality steel to ensure a longer life and much easier cleaning operations.

CLEAN FUNCTION

This function ensures the cleaning of the steam circuit and water container and makes it easier to clean the inner walls.

FM-FCS-450-BISS



-  Fingerprint proof stainless steel
-  Stainless steel interiors
-  Energy Class Efficiency
-  Steel Grill Racks
-  Steam Cooking
-  Steam time scale filter
-  Automatic cooking
-  CLEAN Programmes Automatic Cleaning
-  Temperature measurement probe
-  Safe Door

COMBINED STEAM OVEN

CREACTIVE operating system
Energy Class A++
Finish: Touch proof stainless steel

PERFORMANCE

12 functions
Automatic cooking with pre-selected and customisable recipes (weight, temperature, cooking time)
Steam system
Combined cooking functions
Steam recovery cycle
CLEAN, assisted cleaning cycle for oven interior and steam circuit

FEATURES

Control panel with touch controls
Magnetic water filter
Stainless steel interior
Internal lighting
Internal capacity 34 litres

SAFETY

Safety door
Door contact switch
Control panel safety function
Tangential cooling ventilation

STANDARD ACCESSORIES

Meat probe
1 micro-perforated pan with stainless steel cover
1 stainless steel tray
1 flat rack
Water tank
Power cord with plug

OPTIONAL ACCESSORIES

6 Gastronorm containers with cover in stainless steel, with steel rack.

COMPATIBLE WITH:

Warming drawer (see page 49)

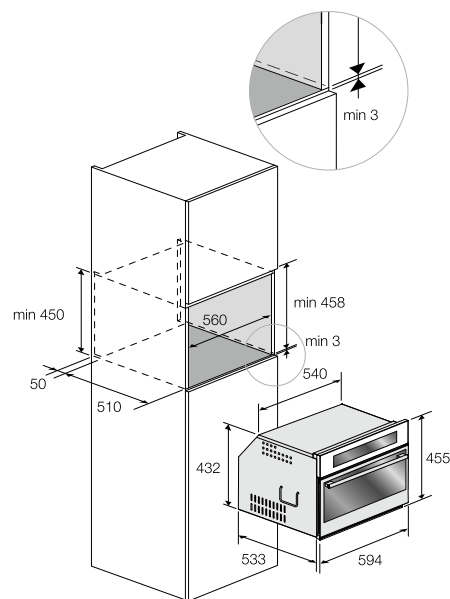

Fingerprint resistant stainless steel
Code EAN 8019801017508



Black glass
FM-FCS-450-BIBL
Code EAN 8019801017607

CREACTIVE

COMPACT 45 MICROWAVE OVEN

Fulgor Milano microwave ovens can function as microwave, grill and fan assisted ovens. These modes can be used separately or combined to help cut down on cooking times and save energy compared to traditional ovens.



CREACTIVE DISPLAY

The Compact 45 oven range comes with cutting-edge electronic technology, offering up to 60 automatic cooking programmes and up to 100 customisable programmes with a simplified memory function via the Creative display.

COMBINED FUNCTIONS

The chance to combine fan assisted mode microwave and electric grill, allows a wide variety of useful cooking modes which enhance the taste and look of your recipes, such as lasagne, flans, meatloaf, etc.

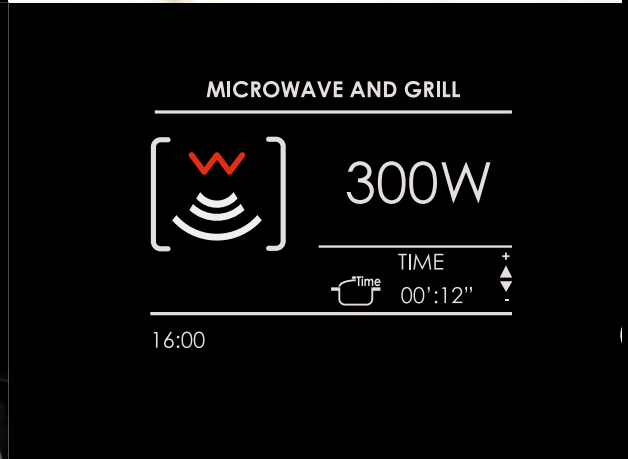
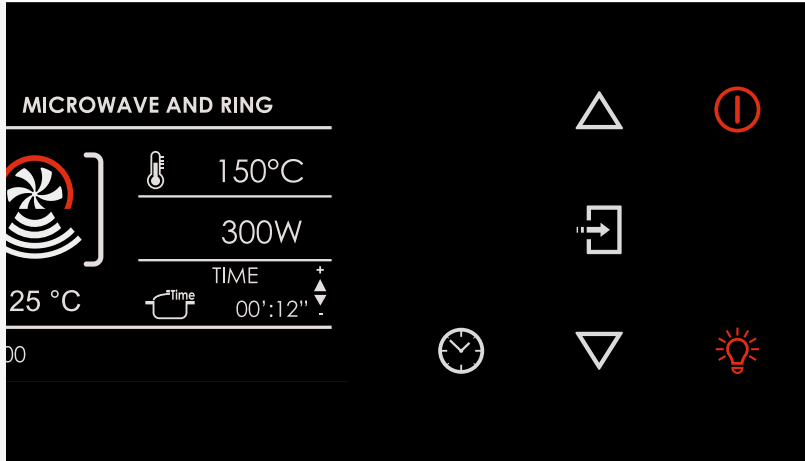

OVEN INTERIOR

The oven interior is made of 10/10 stainless steel for longer life and easier cleaning.

GLASS TURNTABLE

Made of tempered glass, resistant to high temperatures, it helps once cooking with Microwave mode to heat food evenly and completely









ENERGY SAVING

The combination of microwave and baking mode allows you to cut down on cooking time saving energy (compared to traditional cooking only), with excellent cooking results.



FM-FCM-450-BISS



-  Fingerprint proof stainless steel
-  Stainless steel interiors
-  Automatic cooking
-  CLEAN Programmes Automatic Cleaning
-  Microwave cooking
-  Safe Door
-  Power (MW) 1000 W
-  Thawing

COMBINED MICROWAVE OVEN

CREACTIVE operating system
Finish: Touch proof stainless steel

PERFORMANCE

10 combined functions
Automatic cooking
Pre-selected and customizable recipes (weight, temperature, cooking time)
Microwave mode (6 levels) Combined Microwave and fan assisted mode
Combined cooking mode
Microwave and grill mode
Defrosting by time and weight

FEATURES

Control panel with touch controls
Stainless steel interior
Internal lighting
Internal capacity 34 litres

SAFETY

Safety door
Door with safety lock
Door contact switch
Control panel safety function
Tangential cooling ventilation

STANDARD ACCESSORIES

1 round grill rack
1 stainless steel tray with grill support
1 glass turntable
Power cord with plug

COMPATIBLE WITH:

Warming drawer
(see page 49)

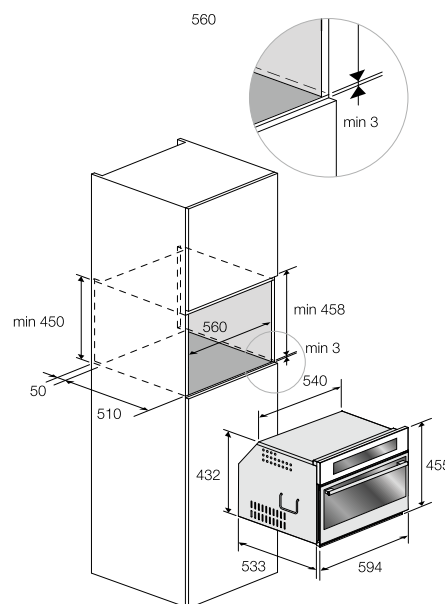

Touch proof stainless steel
Code EAN 8019801017515



Black glass
FM-FCM-450-BIBL
Code EAN 8019801017614

CREACTIVE

COMPACT 45 MULTI-FUNCTION OVEN

The compact multi-function oven, suitable for all space-saving requirements in the kitchen, compatible with all the other models in the Creative Compact 45 range.

Configured with automatic pre-selected recipes and memory to store up to 100 of your own recipes. The perfect combination of thermal and ventilated elements in the cooking chamber results in perfectly even cooking.

COMPACT 45



FM-FMF-450-BISS



Fingerprint proof stainless steel



Steel Grill Racks



Automatic cooking



CLEAN Programmes Automatic Cleaning



Multi-level cooking



Safe Door



Stainless steel interiors



Energy Class Efficiency

ELECTRONIC MULTIFUNCTION OVEN

CREACTIVE operating system
Energy Class A+
Finish in fingerprint resistant stainless steel

PERFORMANCE

14 cooking modes
Pre-selected and customizable recipes (weight, temperature, cooking time)
CLEAN, assisted oven cleaning cycle
BOOST, rapid pre-heating

FEATURES

Control panel with touch controls
Stainless steel interior
Internal lighting
Internal capacity 34 litres

SAFETY

Safety door
Control panel safety function
Tangential cooling ventilation

STANDARD ACCESSORIES

Removable Pizza Stone
Stainless steel tray with rack
Flat rack
Power cord with plug

COMPATIBLE WITH:

Warming drawer
(see page 49)

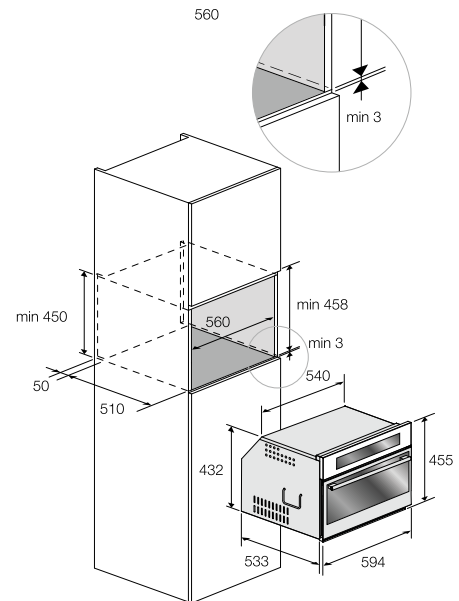

Fingerprint resistant stainless steel
Code EAN 8019801017539



Black glass
FM-FMF-450-BIBL
Code EAN 8019801017638



THE DRAWER THAT KEEPS FOOD WARM



FM-SCV-600-BISS



Sliding
Telescopic
Rails



Slow
cooking



Fingerprint proof
stainless steel



Warming
function



Bevelled
glass



Push Opening



Leavening



Timer



Internal
Ventilation Air +

WARMING DRAWER

Front panel, height 15 cm
Push to open system
Fully removable

PERFORMANCE

Pre-heat dishes
Pre-heat coffee cups
Keep warm ready food
Defrosting
Leavening dough
Slow cooking at 70°C

FEATURES

Internal shelf surface
in black tempered glass
Internal lighting
Fan assisted
Adjustable thermostat from 40°C to 70°C
Automatic cut-off timer
Operation indicator
Safety front

STANDARD ACCESSORIES

Telescopic rails
for sliding open
Power cord with plug

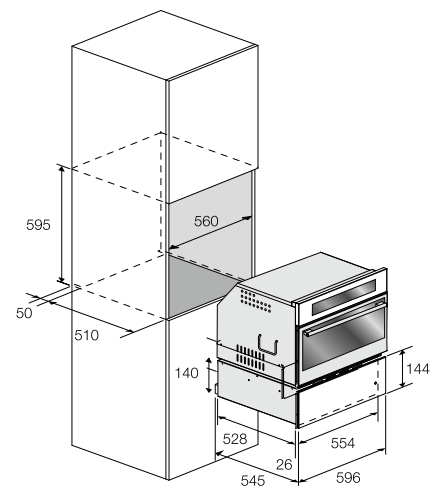

Stainless steel
Code EAN 8019801009206



Black glass
FM-SCV-600-BIBL
Code EAN 8019801010691

FULGOR
MILANO

CREACTIVE

COMPACT 45 WINE COOLER

KEEP WINES AT THE IDEAL STORAGE TEMPERATURE

COMPACT 45



FM-WCR-450-BISS (RIGHT HAND) FM-WCL-450-BISS (LEFT HAND)

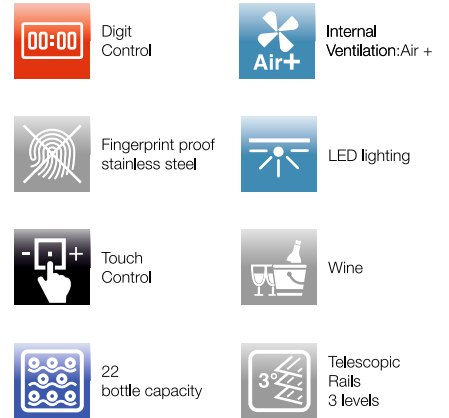

WINE CELLAR

Finish in fingerprint resistant stainless steel swing door (right or left) not reversible

PERFORMANCE

Single temperature
Temperature setting from 5°C to 22°C
Storage of 18 bottles Ø 76 mm and 4 large champagne bottles

FEATURES

Touch controls
Cooling system with compressor
Control Indicator light
Black interior
Internal LED lighting

SAFETY

Anti-vibration system
Anti-condensation system
Anti-UV insulating glass

STANDARD ACCESSORIES

3 wooden shelves
Set of 3 removable telescopic rails
Brackets set to install with drawer
Power cord with plug

COMPATIBLE WITH:

Drawer
(see page 49)

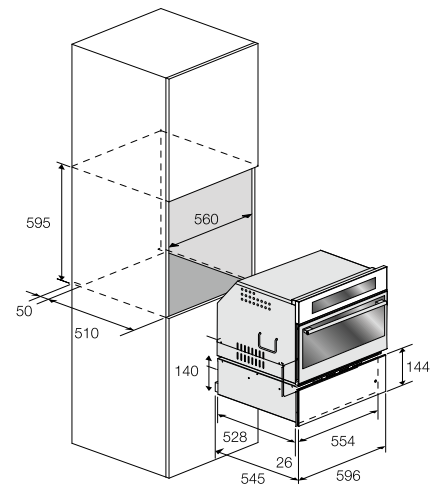

Touch proof stainless steel
Hinge on right
Code EAN 8019801017881
Hinge on left
Code EAN 8019801017928



Black glass
FM-WCR-450-BIBR
Hinge on right
Code EAN 8019801017904
FM-WCR-450-BIBL
Hinge on left
Code EAN 8019801017942









FM-RPFR-1200-FSSS

REFRIGERATION



UPRIGHT SINGLE DOOR FREEZER

- A++ Energy class
- Stainless steel door with handle
- Left hinged (not reversible)
- Total capacity 262 litres
- NO FROST system
- LCD digital display with touch controls
- FAST FREEZE
- Open door acoustic beep
- LED inner lighting
- Anti-bacteria inner liners
- 1 large drawer
- 5 regular drawers
- 1 flap opening compartment
- Automatic defrosting
- Ice cubes tray
- Climate class: SN-T

	External Dimension Identifier		Slot-in Installation
	Fingerprint Proof Stainless Steel		Total No Frost
	Energy Class Efficiency		LED Lighting
	Rapid Thawing		Installation at Hinges

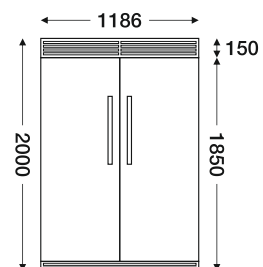
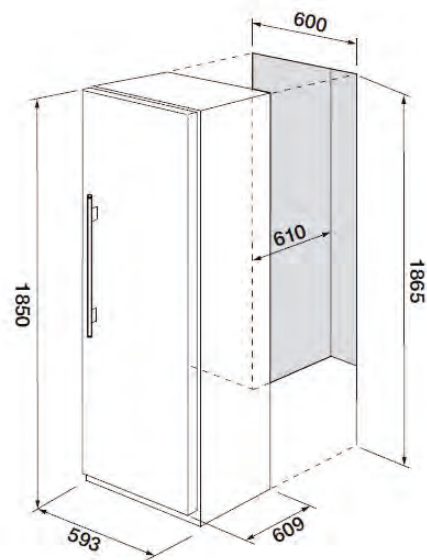

FM-RPRF-1200-FSSS



SINGLE DOOR REFRIGERATOR

- A++ energy class
- Slot-in System
- Right hinged (not reversible)
- Stainless steel door with handle
- Total capacity 352 litres
- LCD digital display with touch controls
- Fast cooling
- Holiday function
- Open door acoustic beep
- ARIA+ fan forced cooling (with stainless steel fan box)
- Acti-bacteria inner liners
- Stainless steel finishing for shelves and balconies frames
- 6 tempered glass shelves with adjustable height
- Metal bottles holder
- 5 door compartments
- Egg container
- 2 crisper drawers
- 1 large bottom drawer
- Automatic defrosting
- Climate class: SN-T

	External Dimension Identifier		Slot-in Installation
	Fingerprint Proof Stainless Steel		Total No Frost
	Energy Class Efficiency		LED Lighting
	Rapid Cooling		Installation at Hinges

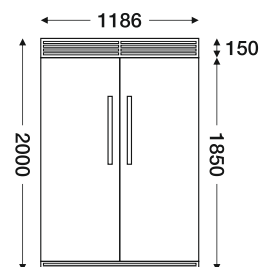
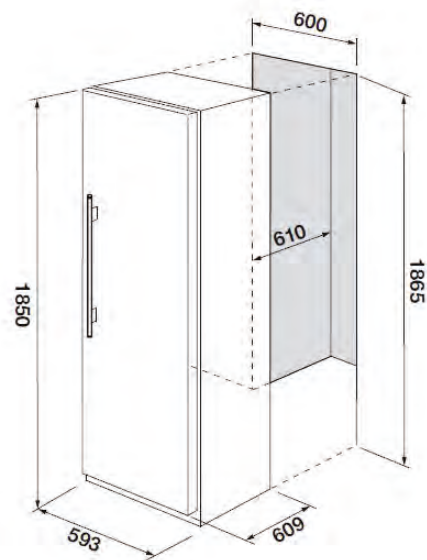

INDUCTION HOBS

SAFETY AND CONTROL WITH A TOUCH

INDUCTION HOBS



SLIDER CONTROLS

The slider sensor controls set the power for each cooking zone.

POWER BOOSTER

To boost the power of each single cooking zone and cutting down down cooking time.

AUTOMATIC POWER OFF

When a cooking zone has been working too long time and the surface overheats, it automatically switches off.

ECO-FRIENDLY GLASS CERAMIC

Surfaces in glass ceramic consist of natural, eco-friendly raw materials.

EXTENDED AREA (BRIDGE)

Versatile and flexible,
to use extra-large
saucepans.

TIMER

This function with a digital display allows
you set cooking times with maximum
precision.



SENSOR FOR DETECTING SAUCEPANS

Automatic detection of pans on single
cooking area through sensors, preventing
them turning on if they are taken off.

SAFETY LOCK

Allows you to stop accidental use
of the hob and prevents damage
and occasional accidents.

RESIDUAL HEAT INDICATOR

The residual heat indicator (H)
warns you not to touch the
hotplate which is still hot.

INDUCTION HOBS

TECHNOLOGY AND EFFICIENCY

INDUCTION HOBS



INDUCTION

The principle of how induction works is simple: an electronic generator powers and controls an electric circuit (inductor) inside the appliance. This circuit creates a magnetic field so that the pan, placed on the glass ceramic surface, is crossed by "induction" currents. Using the Joule effect, these currents transform the pan into the real heat emitter, while the glass ceramic surface remains "cold".

Induction Technology has two main effects:

- a) since the heat is emitted by the pan itself, the heat output is maximised and there is no heat loss during cooking.
- b) there is no thermal inertia because placing the pot on or removing it from the glass ceramic surface instantly starts or stops cooking.

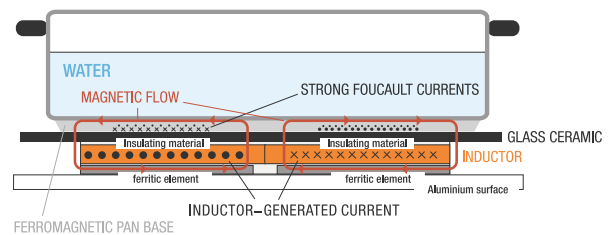

FM-PID-1000-4ZBL

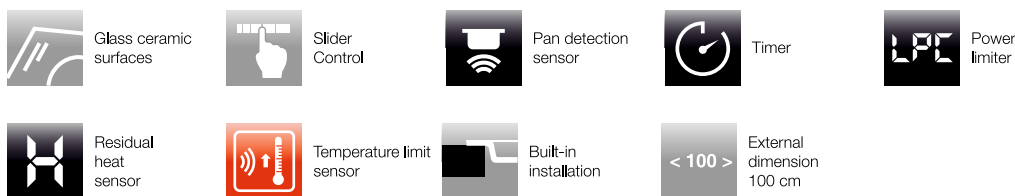

INDUCTION HOB

Glass ceramic surface
Panoramic design

FEATURES

4 zones
LPC limiting power consumption (removable on request)
Automatic heating
End-of-cooking timer

FEATURES

Centralised slider touch controls

SAFETY

Saucepan detection sensor
Safety switch (to prevent accidental use)
Residual heat indicator (H)
Automatic power off with temperature sensor

STANDARD ACCESSORIES

Scraper to clean surfaces

COMPATIBLE WITH:

INDUKIT 4:
Kit of 4 inductor discs for cooking with pans not specifically made for induction cooking

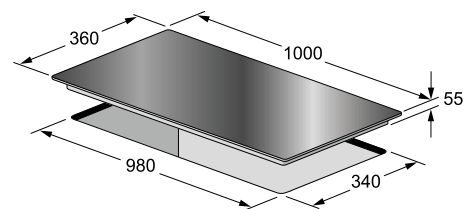

CeraBlack glass ceramic
Code EAN 8019801014354

INDUCTION PERFORMANCE ZONES AND POWER	
Ø 200	2300/3000W
Ø 180	1400/2000W
Ø 160	1200/1400 (x2)W
LPC System = limited power within 3,0 kW	
Max power absorbed (W)	3000W max

FM-PID-900F-5ZBL

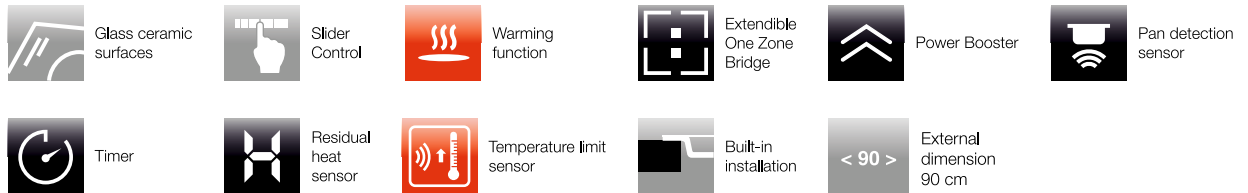
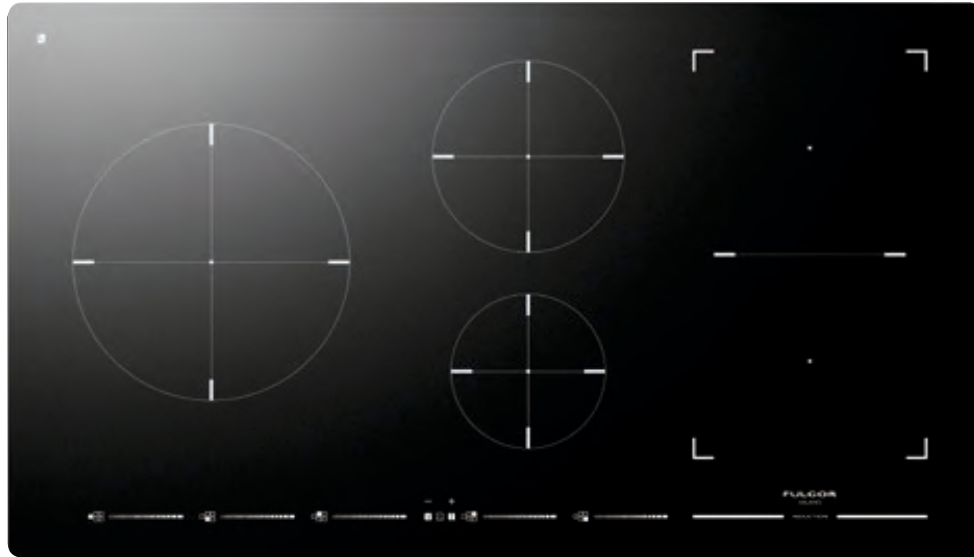

INDUCTION HOB

Glass ceramic surface

PERFORMANCE

5 cooking zones
Assisted cooking in all areas, with 3 pre-configured temperatures: 42°C to melt chocolate etc., 70°C for keeping food warm and slow cooking, 94°C for simmering
Vertical flex function to combine right cooking zones
Booster for rapid heating
Automatic heating
Keep warm function
End-of-cooking timer

FEATURES

Slider touch controls

SAFETY

Saucepan detection sensor
Safety switch (to prevent accidental use)
Residual heat indicator (H)
Automatic power off with temperature sensor

STANDARD ACCESSORIES

Scraper to clean surfaces

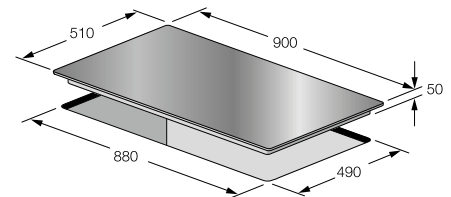

CeraBlack glass ceramic

Code EAN 8019801017720

INDUCTION PERFORMANCE ZONES AND POWER	
Continuous hotplates (8) Ø max pan 260 mm	
Ø 260	2600/3700W
Octagonal	2100/3700 (x2)W
Ø 210	
Ø 180	1850/3000W
Ø 145	1400/2200W
Assisted cooking 42°C melting, 70°C slow cooking, 94°C simmer	
Max power absorbed (W)	11100W max

FM-PID-800B-4ZBL

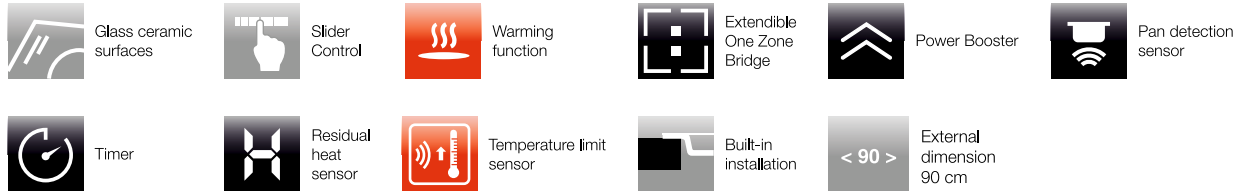
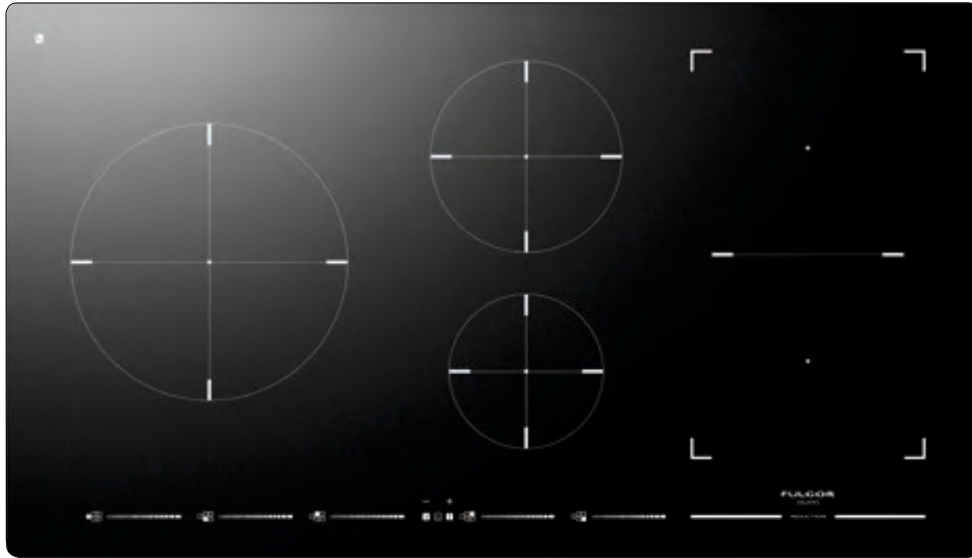

INDUCTION HOB

Glass ceramic surface

PERFORMANCE

5 cooking zones
Assisted cooking in all areas, with 3 pre-configured temperatures: 42°C to melt chocolate etc. 70°C for keeping food warm and slow cooking 94°C for simmering
Vertical flex function to combine right cooking zones
Booster for rapid heating
Automatic heating
Keep warm function
End-of-cooking timer

FEATURES

Slider touch controls

SAFETY

Saucepan detection sensor
Safety switch (to prevent accidental use)
Residual heat indicator (H)
Automatic power off with temperature sensor

STANDARD ACCESSORIES

Scraper to clean surfaces

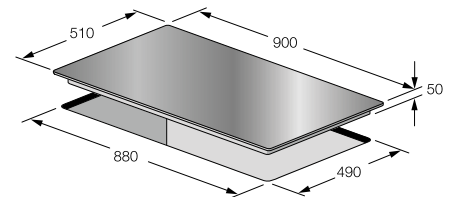

CeraBlack glass ceramic
Code EAN 8019801017720

INDUCTION PERFORMANCE ZONES AND POWER	
Continuous hotplates (8) Ø max pan 260 mm	
Ø 260	
Octagonal	2300/3700 (x2)W
Ø 210	2300/3700W
Ø 180	1850/3000W
Ø 145	
Assisted cooking 42°C melting, 70°C slow cooking, 94°C simmer	
Max power absorbed (W)	7400W max

FM-PID-800-4ZBL

INDUCTION HOBS

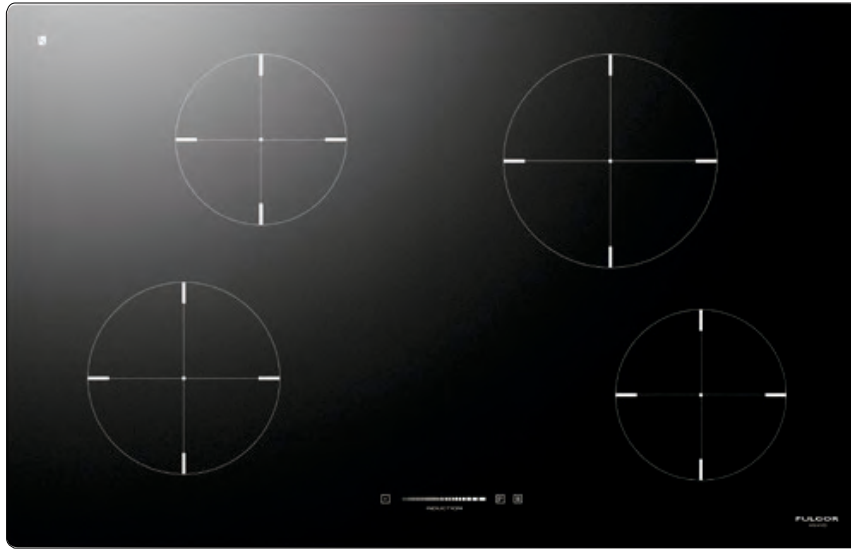

Glass ceramic surfaces



Slider Control



Warming function



Timer



Power limiter



Residual heat sensor



Temperature limit sensor



Built-in installation



External dimension 80 cm

INDUCTION HOB

Glass ceramic surface

FEATURES

4 cooking zones
LPC limiting power consumption (removable on request)
Automatic heating
End-of-cooking timer
Pause function

FEATURES

Centralised slider touch controls

SAFETY

Saucepan detection sensor
Safety switch (to prevent accidental use)
Residual heat indicator (H)
Automatic power off with temperature sensor

STANDARD ACCESSORIES

Scraper to clean surfaces

COMPATIBLE WITH:

INDUKIT 4:
Kit of 4 inductor discs for cooking with pans not specifically made for induction cooking

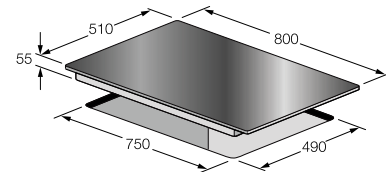

CeraBlack glass ceramic
Code EAN 8019801014392

INDUCTION PERFORMANCE ZONES AND POWER	
Ø 200	2300/3000W
Ø 180	1400/2000W
Ø 160	1200/1400 (x2)W
LPC System = limited power within 3,0 kW	
Max power absorbed (W)	3000W max

FM-PID-600-4ZBL

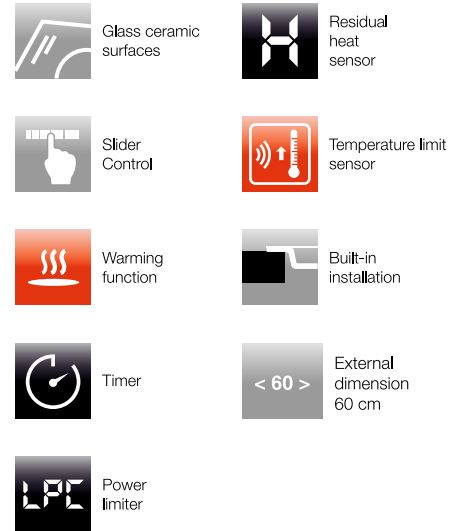
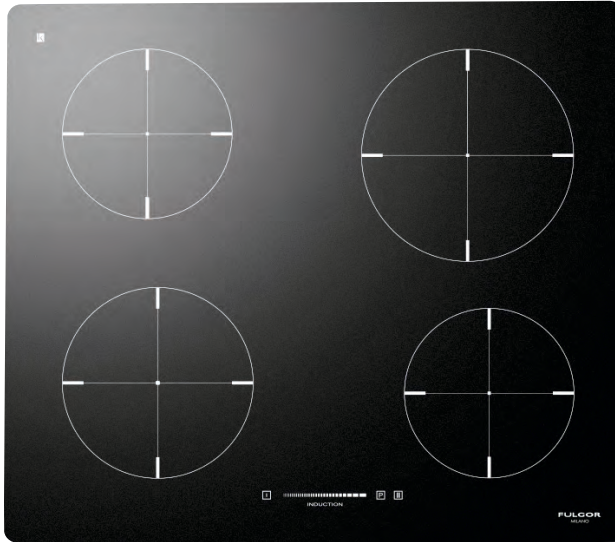

INDUCTION HOB

Glass ceramic surface

FEATURES

4 cooking zones
LPC limiting power consumption (removable on request)
Automatic heating
End-of-cooking timer
Pause function

FEATURES

Central slider touch controls

SAFETY

Saucepan detection sensor
Safety switch (for preventing accidental use)
Residual heat indicator (H)
Automatic power off with temperature sensor

STANDARD ACCESSORIES

Scraper to clean surfaces

COMPATIBLE WITH:

INDUKIT 4:
Kit of 4 inductor discs for cooking with pans not specifically made for induction cooking

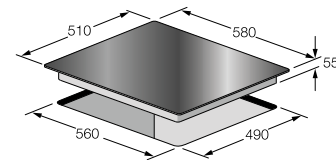

CeraBlack glass ceramic
Code EAN 8019801014415

INDUCTION PERFORMANCE ZONES AND POWER	
Ø 200	2300/3000W
Ø 180	1400/2000W
Ø 160	1200/1400 (x2)W
LPC System = limited power within 3,0 kW	
Max power absorbed (W)	3000W max

FM-PIC-900-4ZBL

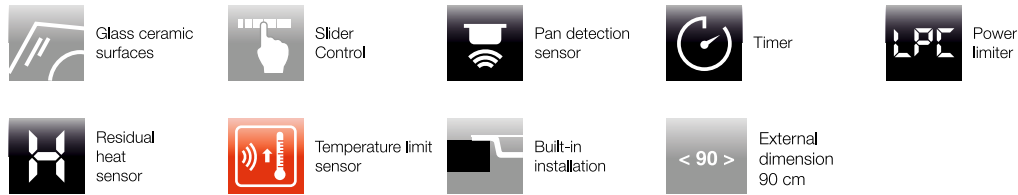
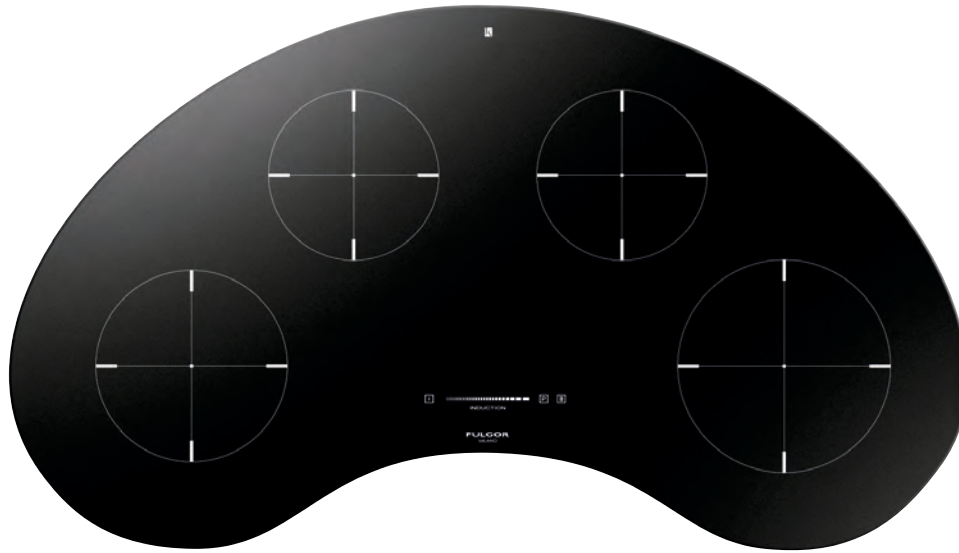

INDUCTION HOB

Glass ceramic finish
Curve design

FEATURES

4 cooking zones
LPC limiting power consumption (removable on request)
Automatic heating
End-of-cooking timer
Pause function

FEATURES

Centralised slider touch controls

SAFETY

Saucepan detection sensor
Safety switch (to prevent accidental use)
Residual heat indicator (H)
Automatic power off with temperature sensor

STANDARD ACCESSORIES

Scraper to clean surfaces

COMPATIBLE WITH:

INDUKIT 4:
Kit of 4 inductor discs for cooking with pans not specifically designed for induction cooking

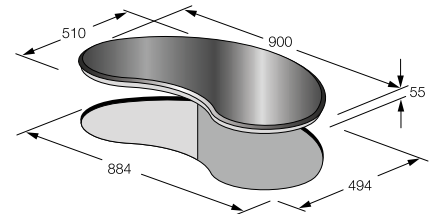

CeraBlack glass ceramic
Code EAN 8019801014347

INDUCTION PERFORMANCE ZONES AND POWER	
Ø 200	2300/3000W
Ø 180	1400/2000W
Ø 160	1200/1400 (x2)W
LPC System = limited power within 3,0 kW	
Max power absorbed (W)	3000W max

FM-PGI-900-5ZBL

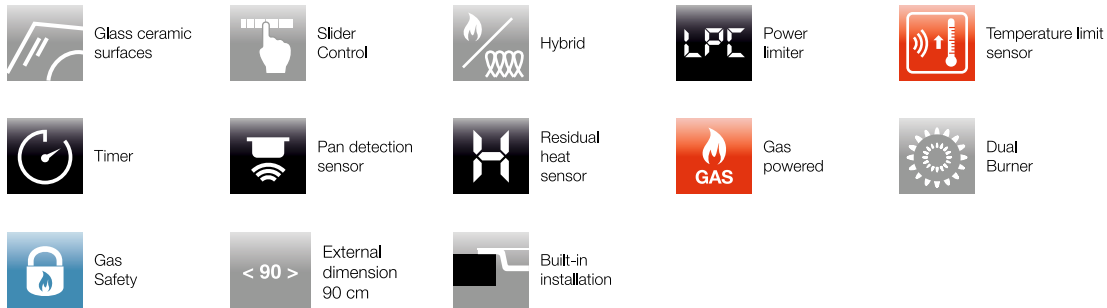
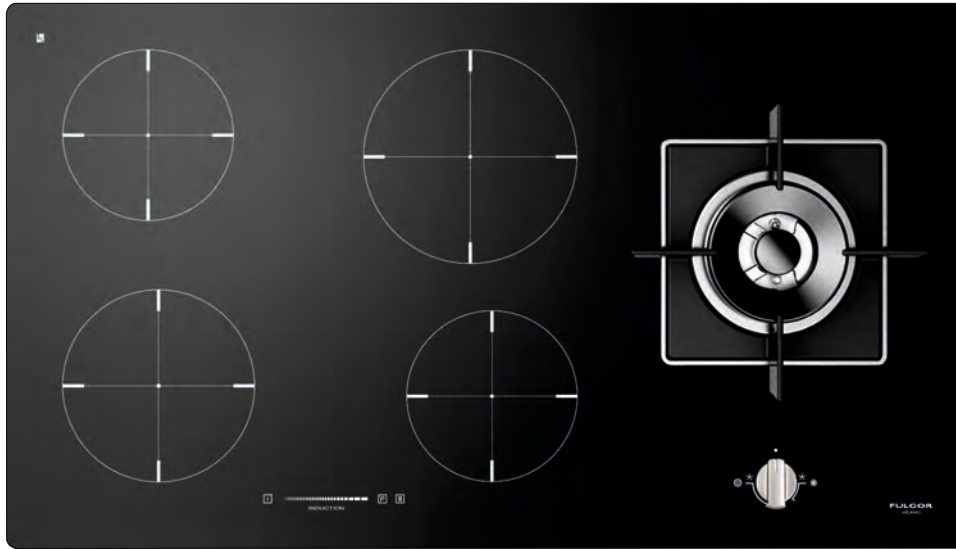

HYBRID GAS/INDUCTION HOB

Glass ceramic surface

FEATURES

- 4 induction cooking zones
- LPC limiting power consumption (removable on request)
- Automatic heating
- End-of-cooking timer
- Pause function
- Brass large gas burner (4,0 kW)

FEATURES

- Central slider touch controls
- Dual regulation for gas burners, with steel control
- Cast iron burner cap

SAFETY

- Saucepan detection sensor
- Safety switch (to prevent accidental use)
- Residual heat indicator (H)
- Automatic power off with temperature sensor
- Gas detection and stop gas system (burner)

STANDARD ACCESSORIES

- Scraper to clean surfaces
- Cast iron adaptor for Woks
- Cast iron reducer for small pans

COMPATIBLE WITH:

- INDUKIT 4: kit of 4 inductor discs for cooking with non-induction pans

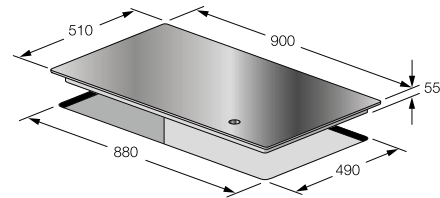

CeraBlack glass ceramic
Code EAN 8019801017706

INDUCTION PERFORMANCE ZONES AND POWER	
Ø 200	2300W
Ø 180	1400W
Ø 160	1400 (x2)W
LPC System = limited power within 3,0 kW	
Max power absorbed (W)	3000W



FULGOR
MILANO





GAS HOBS

GAS HOBS

PERFORMANCE WITH STYLE AND FLEXIBILITY

GAS HOBS



GAS PROTECT DOUBLE STEP

For increased safety while using Plano gas hobs a second safety valve has been added to the regular one on each burner, acting on the gas supply connection directly, allowing to switch off all burners together at the same time if required.

SETTING COOKING TIME

Plano hobs are equipped with a timer to set cooking time of each burner independently, turning off automatically at the end.

AUTOMATIC GAS RE-IGNITION

If the flame goes out, the automatic re-ignition will try 3 times to restart the burner; if it fails the flame failure device will stop the gas supply (Gas Protekt).



GAS HOBS

LONG COOKING AT LOW TEMPERATURES

This innovative function allows for cooking of special recipes (preserves, marmalades, sauces, chocolate, etc.) by turning any burner on the hob on or off in a definable sequence within 60 seconds to maintain a low temperature extended over time (up to 4 hours).

CAST IRON FLUSH-FIT PAN SUPPORTS

The cast iron pan supports included in the Creative Plano series are designed to offer the best flush fit possible while maintaining the efficiency of the burners and preventing heat dispersion of the flame. For increased protection of the solid surface work tops, the outer part of the grids has been made thicker.

FM-PGA-1120-4BSS



Gas powered



Wok Burner



Gas Safety



Built-in top installation



External dimension 112 cm

GAS HOB

Stainless steel finish

PERFORMANCE

4 in-line burners including 1 Wok burner (4,0 kW)

FEATURES

Electronic ignition
Steel rotary controls
Cast iron pan supports

SAFETY

Gas detection and stop gas system

STANDARD ACCESSORIES

Cast iron adaptor for Woks
Cast iron reducer for small pans
Power cord with plug

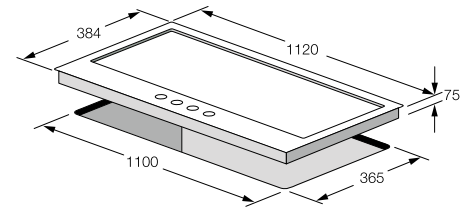

Stainless steel
Code EAN 8019801011032

GAS PERFORMANCE BURNERS AND POWER

Front right	Rapid / 3000W
Rear right	
Front centre right	Auxiliary / 1000W
Central	
Front centre left	Semi-rapid / 1750W
Front left	Triple ring / 4000W
Rear left	

FM-PGA-860-5BSS



Gas powered



Wok Burner



Gas Safety



Built-in top installation



External dimension 90 cm

GAS HOB

Stainless steel finish

PERFORMANCE

5 Burners including 1 Wok burner (4,0 kW)

FEATURES

Electronic ignition
Steel rotary controls
Cast iron pan supports

SAFETY

Gas detection and stop gas system

STANDARD ACCESSORIES

Cast iron adaptor for Woks
Cast iron reducer for small pans
Power cord with plug

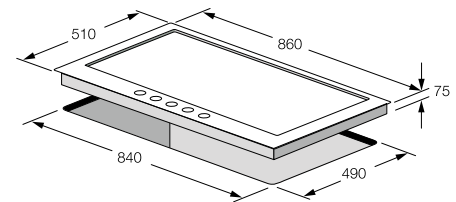

Stainless steel
Code EAN 8019801011049

GAS PERFORMANCE BURNERS AND POWER

Front right	Semi-rapid / 1750W
Rear right	Semi-rapid / 1750W
Front centre right	
Central	Triple ring / 4000W
Front centre left	
Front left	Auxiliary / 1000W
Rear left	Rapid / 3000W

FM-PGA-770-5BSS



Gas powered



Wok Burner



Gas Safety



Built-in top installation



External dimension 76 cm

GAS HOB

Stainless steel finish

PERFORMANCE

5 Burners including 1 Wok burner (4.0 kW)

FEATURES

Electronic ignition
Steel rotary controls
Cast iron pan supports

SAFETY

Gas detection and stop gas system

STANDARD ACCESSORIES

Cast iron adaptor for Woks
Cast iron reducer for pans with small bases
Power cord with plug

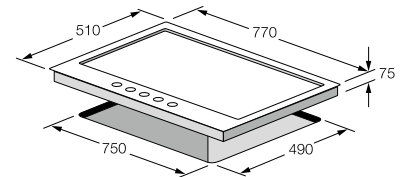

Stainless steel
Code EAN 8019801011056

GAS PERFORMANCE BURNERS AND POWER

Front right	Semi-rapid / 1750W
Rear right	Semi-rapid / 1750W
Front centre right	
Central	Triple ring / 4000W
Front centre left	
Front left	Auxiliary / 1000W
Rear left	Rapid / 3000W

FM-PGA-590-4BSS



Gas powered



Wok Burner



Gas Safety



Built-in top installation



External dimension 60 cm

GAS HOB

Stainless steel finish

PERFORMANCE

4 Burners

FEATURES

Electronic ignition
Steel rotary controls
Cast iron pan supports

SAFETY

Gas detection and stop gas system

STANDARD ACCESSORIES

Cast iron reducer for pans with small bases
Power cord with plug

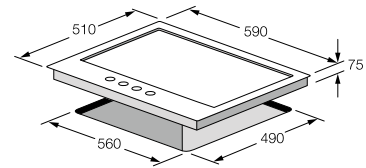

Stainless steel
Code EAN 8019801011063

GAS PERFORMANCE BURNERS AND POWER	
Front right	Semi-rapid / 1750W
Rear right	Semi-rapid / 1750W
Front centre right	
Central	
Front centre left	
Front left	Auxiliary / 1000W
Rear left	Rapid / 3000W



FULGOR

MILANO

www.fulgor-milano.co.uk

euroline
exclusive appliance importer

Euroline is the exclusive UK importer of Fulgor Milano

8 De Grey Square, De Grey Road, Colchester, Essex, CO4 5YQ

W: www.euroline.co.uk | E: hello@euroline.co.uk | T: 01206 849 900 | F: 01206 615 422